

AMP 2 & AMP 3 Power Amplifiers

PROCEED

WARNING: TO REDUCE THE RISK OF FIRE OR ELECTRIC SHOCK, DO NOT EXPOSE THIS APPLIANCE TO RAIN OR MOISTURE.

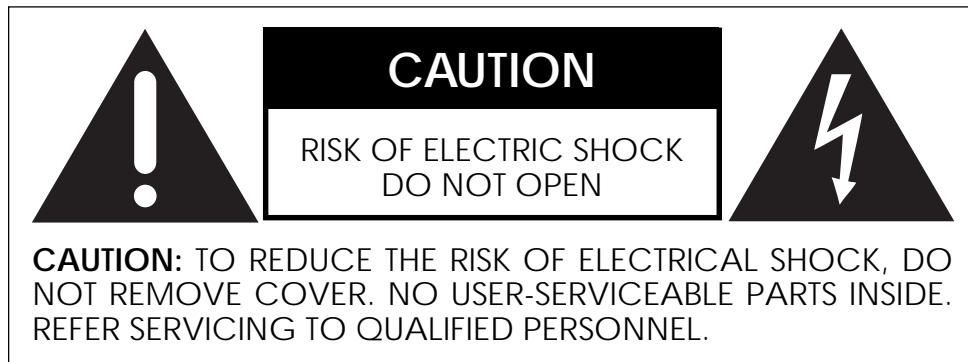

The lightning flash with arrowhead symbol, within an equilateral triangle, is intended to alert the user to the presence of uninsulated “dangerous voltage” within the product’s enclosure that may be of sufficient magnitude to constitute a risk of electric shock to persons.



The exclamation point within an equilateral triangle is intended to alert the user to the presence of important operating and maintenance (servicing) instructions in the literature accompanying the appliance.



Marking by the “CE” symbol (shown left) indicates compliance of this device with the EMC (Electromagnetic Compatibility) and LVD (Low Voltage Directive) standards of the European Community.

The information contained in the manual is subject to change without notice. The most current version of this manual will be posted on our web site at <http://www.madrigal.com>.

Important Safety Instructions

Please read all instructions and precautions carefully and completely before operating your Proceed power amplifier.

1. **ALWAYS** disconnect your entire system from the AC mains before connecting or disconnecting any cables, or when cleaning any component.
2. This product is equipped with a three-conductor AC mains power cord which includes an earth ground connection. To prevent shock hazard, all three connections must **ALWAYS** be used. If your electrical outlets will not accept this type of plug, an adapter may be purchased. If an adapter is necessary, be sure it is an approved type and is used properly, supplying an earth ground. If you are not sure of the integrity of your home electrical system, contact a licensed electrician for assistance.
3. AC extension cords are not recommended for use with this product. If an extension cord must be used, be sure it is an approved type and has sufficient current-carrying capacity to power this product.
4. **NEVER** use flammable or combustible chemicals for cleaning audio components.
5. **NEVER** operate this product with any covers removed.
6. **NEVER** wet the inside of this product with any liquid.
7. **NEVER** pour or spill liquids directly onto this unit.
8. **NEVER** block air flow through ventilation slots or heatsinks.
9. **NEVER** bypass any fuse.
10. **NEVER** replace any fuse with a value or type other than those specified.
11. **NEVER** attempt to repair this product. If a problem occurs, contact your Proceed® retailer.
12. **NEVER** expose this product to extremely high or low temperatures.
13. **NEVER** operate this product in an explosive atmosphere.
14. **ALWAYS** keep electrical equipment out of the reach of children.
15. **ALWAYS** unplug sensitive electronic equipment during lightning storms.

From all of us at Madrigal Audio Laboratories, thank you for choosing the Proceed power amplifier.

A great deal of effort went into the design and construction of this precision device. Used properly, it will give you many years of enjoyment.

Table of Contents

Unpacking and Placement	6
Unpacking	6
Placement	6
Ventilation	6
Operating Voltage	7
<i>AMP bottom-panel label</i>	7
A Quick Start	8
Special Design Features	10
Multiple monaural design	10
Low impedance power supply	10
Balanced inputs	10
Robust output stage	10
Extensive protection	10
Home THX Audio System certification	11
Front Panel	12
Rear Panel	13
<i>Remote turn-on tip polarity</i>	14
Bridged Operation	17
Bridging Explained	17
Balanced Bridging	17
<i>Balanced Bridging Kit</i>	17
<i>Balanced Bridged Input Connection</i>	18
Single-Ended Bridging	19
<i>Single-Ended Bridging Kit</i>	20
<i>Single-Ended Bridged Input Connection</i>	21
Biamplication	22
<i>Balanced Y-adapter</i>	22
<i>Biamping wiring diagram</i>	23
Care & Maintenance	24
U.S. and Canadian Warranty	25
90-Day Limited Warranty	25
Five Year Extended Warranty	25
Obtaining Service	26
Specifications	27
Dimensions: AMP 2	28
Dimensions: AMP 3	29

Unpacking and Placement

Unpacking Unpack your Proceed® AMP 2 or AMP 3 power amplifier and **keep all packing materials for future transport**. Shipment of the amplifier without the original packing material is *not* recommended. Locate and remove the heavy gauge AC power cord, which is tucked into a cardboard slot within the box.

Placement Your Proceed AMP may be placed either near the preamplifier/control center or near the loudspeakers. It may be placed on a shelf or in a cabinet where it is convenient to operate.

Note that adequate clearance for the AC cord and connecting cables must be left behind your AMP. We suggest leaving at least three inches of free space behind your AMP to allow all cables sufficient room to bend without crimping or undue strain.

Ventilation Be sure to allow 2 to 3 inches of clearance above your AMP to allow heat dissipation through air circulation. The vents on both the bottom and the top of the AMP must be kept free from any obstruction which would reduce the flow of air through the unit. The best rule of thumb is this: if the top of your AMP is too hot to touch when “idle,” it needs better ventilation. If so, consider drilling holes in the supporting shelf under the AMP to promote flow-through ventilation, or use fans to increase air circulation.

Open equipment racks are generally best for power amplifiers, as they allow ample ventilation. If your amplifier must be located inside a cabinet which restricts airflow, consider using some fans to increase ventilation.

Avoid placement on soft surfaces such as carpeting. If you prefer to have the AMP on the floor near your loudspeakers, be sure to place it on a firm surface. (A piece of tempered glass under the amplifier is aesthetically unobtrusive while providing firm support and allowing the required ventilation.)

Mechanical drawings are included in this manual to facilitate special installations and custom cabinet work (see “Dimensions” at the end of this manual).

PRECAUTION

For your protection, review “Important Safety Instructions” before you install your AMP.

Operating Voltage

The Proceed AMP 2 and AMP 3 are factory-set for 100V, 120V, 220V, or 240V AC mains operation at either 50 or 60Hz, according to the country for which the unit was manufactured. (*230V in European Union countries, in compliance with CE regulations*) Make sure that the label on the bottom of the AMP indicates the correct AC operating voltage for your location. The operating voltage cannot be changed by the user, and any attempt to do so will void the warranty.

If the voltage indicated does not match the service in your area, see your Proceed dealer.

AMP bottom-panel label



A Quick Start

We recognize that many people are understandably eager to begin listening to their new components, and that reading the manual is often done (if at all) at a later time—perhaps while listening to music through the new product itself. We strongly recommend that you read this manual thoroughly.

Fortunately, we can help you get some music up and running on your system quickly, so that you may begin enjoying your new amplifier while reading more about it. The goal here is simply to make some music as quickly as possible.

The following procedure assumes that the rest of your system is already connected (e.g., source components to preamplifier).

1 TURN DOWN THE VOLUME ON YOUR PREAMPLIFIER

Turning the volume on the preamp all the way down minimizes the opportunity for unpleasant surprises when first powering up your new amplifier. It does not need to be turned off—merely turned down.

2 SELECT “XLR” OR “RCA” WITH THE “INPUT SELECT” SWITCHES

Each channel of the Proceed AMP 2 and AMP 3 has both balanced (XLR) and single-ended (RCA) inputs, with a small switch between the two connectors to select between them. Using these switches, select the appropriate input for each channel, given your interconnecting cables and preamplifier's capabilities.

3 CONNECT YOUR PREAMP TO THE AMP

Having selected the appropriate inputs in Step 2, now connect the outputs of your preamplifier to the corresponding inputs on the power amplifier.

4 CONNECT YOUR SPEAKERS TO THE AMP

Each channel of the Proceed AMP 2 and AMP 3 is supplied with two sets of binding posts to facilitate bi-wiring. Using either the top or the bottom set of red and black binding posts, connect speaker wire from the AMP to your loudspeakers. Be sure to maintain consistency in polarity, e.g., the red post on the amplifier to the red connector on the speaker, and likewise black to black. (Getting the wires mixed up won't damage anything, but the sound will be lacking in bass and the imaging will be quite poor and unstable.)

5 CONNECT THE AC CORD TO THE AMP AND TO YOUR AC OUTLET

The AC receptacle for the power cord is located on the right side of the rear panel, as seen from the front. The AMP will initially power up in standby mode.

6 TURN ON THE AMP BY PRESSING THE POWER BUTTON

Pressing the latching power button on the front panel of the AMP 2 and AMP 3 will connect the amplifier to the AC mains. If the indicator light does not light, the amplifier is either not receiving AC power or its protection circuitry has been engaged.

7 SLOWLY RAISE THE VOLUME ON YOUR PREAMPLIFIER

Congratulations! You should now be able to enjoy your favorite music while reading the rest of this manual. *(Please, do read the rest of this manual. It contains much valuable information about your new amplifier which we could not possibly fit onto these two pages)*

Special Design Features

Congratulations on your purchase of a Proceed AMP! While your new amplifier is straightforward in its use, it includes several design features which are responsible for its outstanding performance. A few of these are given below.

Multiple monaural design

Consistent with the finest amplifiers, your Proceed AMP is a true “multiple monaural” design. Each audio channel has its own, dedicated power supply—including a separate 300VA toroidal transformer for each channel. This approach reduces crosstalk between audio channels for superior imaging and reproduction of acoustic space. The demands placed on one channel have virtually no effect on the performance of the other channel(s).

Low impedance power supply

A critical factor in the ultimate performance of an amplifier is its “power supply impedance,” which can be loosely thought of as the freedom with which the audio circuitry has access to the power it needs, when it needs it. The design of your Proceed AMP has addressed this important characteristic in a comprehensive fashion. For example, the power supply capacitors (which act as “reservoirs” of power for the amplifier circuitry) are mounted directly to the printed circuit board, immediately adjacent to the output transistors (which require the greatest amount of current). The layout of the circuitry uses short, thick traces for high current paths. Internal current capability is further enhanced with high purity copper buss bars. This attention to detail yields an optimal environment in which the amplifier may operate to its maximum potential.

Balanced inputs

Each channel of your AMP is individually configurable to receive either balanced or single-ended inputs. This approach allows you to take full advantage of the greater immunity from noise, RFI, and EMI which balanced transmission of audio signals offers on any preamp-to-amplifier connection where it is supported. At the same time, any or all channels of the amplifier may be configured for single-ended inputs to maintain compatibility with the majority of preamplifiers available today. The gain structure of the AMP adjusts automatically when you select different inputs to facilitate this “mix and match” approach.

Robust output stage

Each channel of your Proceed AMP uses eight 150 watt power transistors. These transistors are all individually tested and sorted, and are used in matched sets to ensure that no one transistor bears a disproportionate part of the overall load. The combination of an “overbuilt” design specification and extraordinary attention to detail in manufacturing improves performance, reliability, and longevity.

Extensive protection

Your Proceed amplifier will shut itself down if it senses either the presence of DC (direct current) at the output or an unsafe operating temperature. In either case, a power relay will cause the amplifier to be disconnected from the AC mains. In addition, the AC input to each transformer is fused to protect against excessive current conditions such as driving shorted outputs. Finally, inrush limiting prevents premature aging of power supply components during power-up, and switches off-line once the power supply has been charged.

Home THX Audio
System certification

Lucasfilm, Ltd.® has established minimum standards for the performance of various components which may be used in their Home THX® Audio System. With respect to power amplifiers, the standards address such things as:

- a low electrical noise floor to allow low-level information to be fully appreciated;
- the absence of any mechanical noise (fans noise, transformer winding buzzes), for the same reason;
- adequate power to meet the demands of modern films (which can be *quite* dynamic);
- flat frequency response for accurate reproduction of timbre;
- stability into relatively extreme loudspeaker loads, to ensure that the amplifier will perform well with a wide range of loudspeakers.

As you can see from this list, there is nothing about the Home THX amplifier specification that is particularly radical. It simply ensures a certain minimum standard of performance. In particular, there is nothing in the nature of the amplifier specification which prevents anyone from going above and beyond the minimum performance levels required by THX certification.

Both the Proceed AMP 2 and AMP 3 are certified for use in Home THX audio systems. In these products, Madrigal engineers have created powerful, versatile and extraordinarily *musical* power amplifiers, using the technology and design methodology for which they have become so well known. Equally suited to the rigors of film soundtracks and the finesse of high end music reproduction, the Proceed amplifier serves both needs quite well. In today's growing market for multi-purpose systems, they represent an extraordinary value.

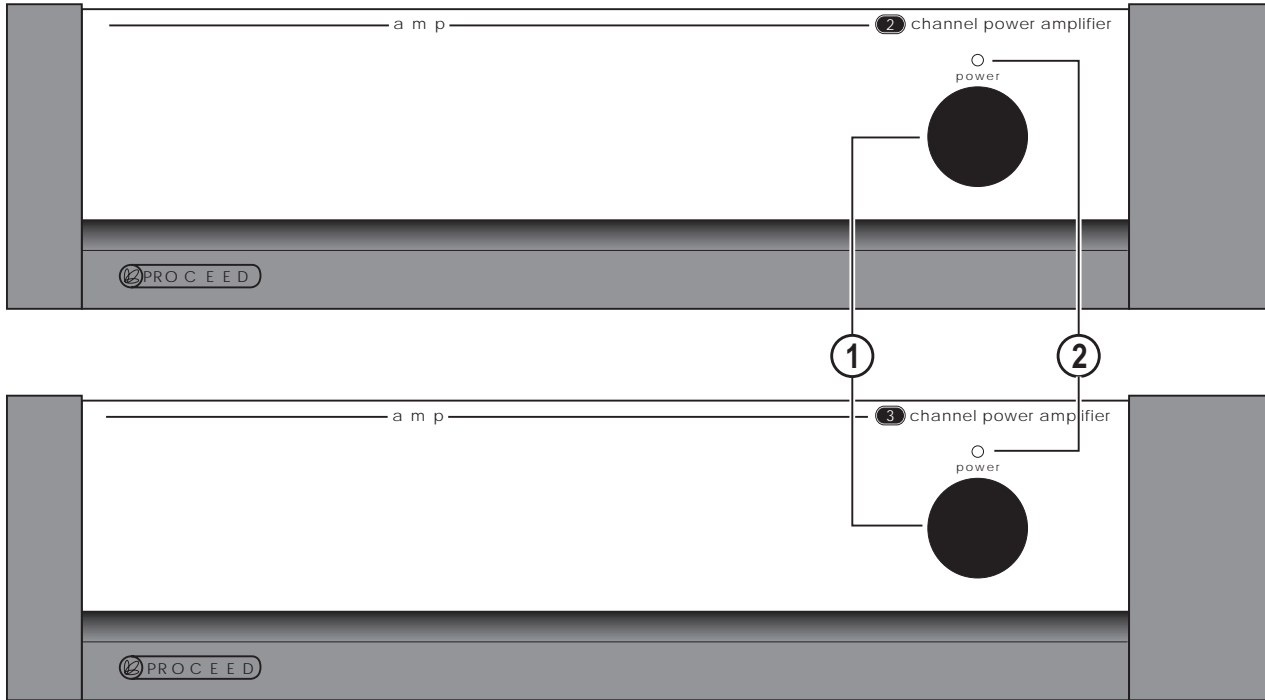

Front Panel

1 POWER BUTTON

Pressing the latching **power** button connects the amplifier to the AC mains, turning it **on**. Power consumption when fully on and at idle is approximately 140 watts for the AMP 2 and 210 watts for the AMP 3.

At your option, you may also toggle the AMP between a **standby** mode and **fully on** by connecting its **remote turn on jack** to the corresponding **remote turn on output** on a Proceed control unit such as the PAV, PRE, or even the CDP. Power consumption in **standby** mode is extremely small—just a few watts for the circuitry which controls the turn-on procedure.

Note that if the amplifier has been disconnected from the AC mains power by depressing the front panel **power** button, it cannot respond to a remote turn-on command from a control unit.

2 INDICATOR LIGHT

The **indicator light** glows either amber or red, depending on the operational status of your AMP. Amber indicates that the AMP is **on** and ready to be used. When the indicator light is glowing red, the unit is in **standby** (see 1 above). If the indicator light is completely off, the amplifier is not receiving power. Check your AC connections and the rear-panel AC fuse.

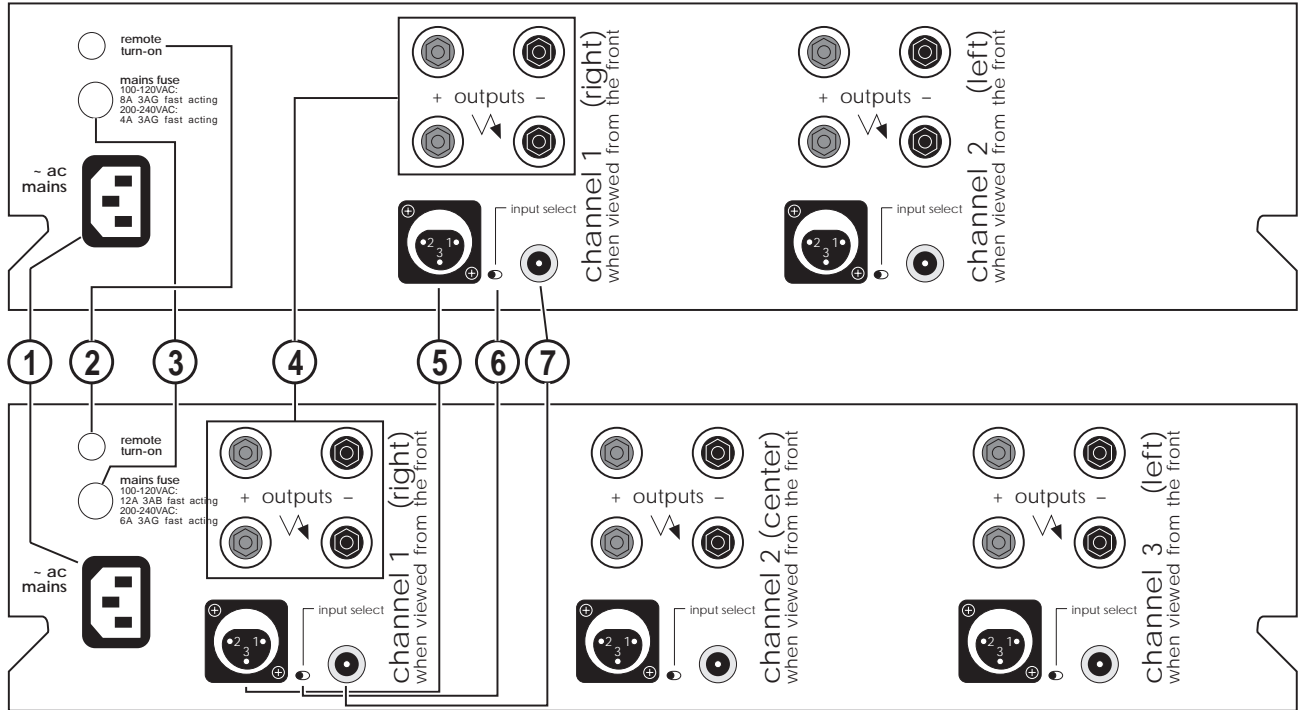

Rear Panel



Caution!

Turn the volume on your preamplifier all the way down before attempting to connect anything to your Proceed AMP 2 or AMP 3.



Warning!

The Proceed AMP has been safety-tested and is designed for operation with a three-conductor power cord. Do not defeat the "third pin" or earth ground of the AC power cord.

1 AC MAINS RECEPTACLE

Connect the AC power cord (included in the accessory pack) to the I.E.C.-standard AC receptacle on the rear panel of the AMP, then to the AC mains outlet.

Remote turn-on
tip polarity

2 REMOTE TURN-ON JACK

A 1/8" "mini" jack above the AC mains receptacle on the rear panel allows remote-controlled turn-on (that is, toggling between operate and standby) of the Proceed AMP. This remote "trigger" will be operated by a 3–12 volts DC positive-polarity pulse, of at least 100 milliseconds duration, with tip polarity as shown below:

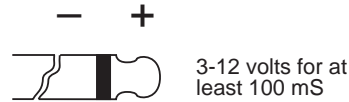

Your Proceed dealer can help you take advantage of these design features to maximize your system's versatility.

3 AC MAINS FUSE

One fast-blow fuse is located on the rear panel of the AMP. If it should become necessary, replace the fuse with the same type only. Refer to the following table for replacement values.

	<u>AMP 2</u>	<u>AMP 3</u>
100V to 120VAC	8 amp	12 amp
200V to 240VAC	4 amp	6 amp



Caution!

ALWAYS remove the AC cord before removing the fuse!

4 SPEAKER BINDING POSTS

The Proceed AMP is equipped with gold-plated, high-current binding posts for output termination to a loudspeaker system. To take full advantage of the AMP's sonic quality, we recommend using high-quality speaker cable; see your Proceed dealer.



Caution!

NEVER connect the Proceed AMP output terminals to any device other than a loudspeaker.
NEVER short-circuit the amplifier's output terminals.
NEVER connect the left-channel output terminals to the right-channel output terminals.

There are two recommended methods for connecting speaker cables to the Proceed AMP. A high-quality spade lug or hook lug, soldered to the cable (or crimped with extremely high pressure), is best.



Connect the left-channel + (positive or red) output post of the Proceed AMP to the + (positive or red) input terminal of the appropriate loudspeaker.

Connect the left-channel - (negative or black) output post of the AMP to the - (negative or black) input terminal of the appropriate loudspeaker.

Repeat this procedure for the remaining channel(s).

5 BALANCED AUDIO INPUTS

Accepts right-channel and left-channel signals from preamplifiers with balanced outputs via high quality XLR connectors.

The pin assignments of these XLR-type female input connectors are:



Pin 1: Signal ground

Pin 2: Signal + (non-inverting)

Pin 3: Signal - (inverting)

Connector ground lug: chassis ground

These pin assignments are consistent with the standards adopted by the Audio Engineering Society. Refer to the operating manual of your balanced-output preamplifier to verify that the pin assignments of its output connectors correspond to your Proceed AMP. If not, wire the cables so that the appropriate output pin connects to the equivalent input pin.

If you are planning to use balanced connections between your preamplifier and any particular channel of the AMP, select the balanced input by sliding the **input select switch** (see Item 6, below) toward the XLR input. Then connect the balanced outputs of your preamplifier to the corresponding balanced inputs on the AMP.

6 INPUT SELECT SWITCH

This small switch is found between the balanced XLR input and the single-ended RCA input on each channel of the AMP. Use it to select which of the two inputs you plan to use.

The input select switch disables the unselected input in order to avoid any pickup of stray noise from an open input. It also causes the effective gain of that channel to be adjusted (either 23 dB balanced or 29 dB single-ended, to compensate for the 6 dB difference in signal level in these two connection standards). Should you use your AMP in a home theater system, this adjustment allows you to use any combination of balanced and single-ended connections without having to worry about going outside the adjustment range of your Dolby™ Pro Logic™ decoder's output calibration circuitry.

7 SINGLE-ENDED INPUTS

These RCA connectors accept single-ended inputs from preamplifiers with single-ended (RCA) outputs.

Connect the left-channel single-ended outputs of your preamplifier to the left-channel single-ended input on the AMP. Repeat for the remaining channel(s).

Bridged Operation

Your Proceed amplifier has been designed to be extremely versatile. Should your needs change or grow over time, you may wish to add additional power by one of two means: Bridging, or Biamping. We will discuss bridged operation first.

Bridging Explained

Bridging refers to the act of reconfiguring the circuitry in both the left and right channels of your amplifier to act as though it were a single, much larger amplifier. (Of course, you will need a second bridged amplifier for stereo; more for multichannel sound, as in home theater applications.)

Bridging is accomplished by sending a normal signal to one channel and an *inverted* signal to the other. In this configuration, one channel will always be “pushing” when the other is “pulling.” By connecting the loudspeaker leads across the left and right red output terminals, the amplifier can now deliver twice the normal voltage to the loudspeaker. Working together this way, the two amplifier channels can deliver almost *four times* the power to a speaker that a single channel could deliver on its own.

Bridged operation is particularly beneficial with low sensitivity, high-impedance loudspeakers (8Ω or higher) that have a greater need for voltage than for current. It is not recommended for low-impedance loudspeakers, as the speaker’s impedance is “split” by the two halves of the amplifier. Thus the bridged amplifier “sees” a 2Ω load when connected to a 4Ω loudspeaker. Delivery of high power into such a low impedance creates a great deal of heat that needs to be dissipated. (Of course, your amplifier is protected against overheating, but having an amplifier shut itself down even temporarily can put a damper on the evening’s entertainment.)

Balanced Bridging

If your preamplifier has balanced outputs, you should use them. For this discussion, we will assume that you are using a Madrigal Balanced Bridging Kit for each channel to be bridged. (Alternatively, you may have custom cables built using your preferred wire and connectors, being careful to follow the wiring diagram below.)

Balanced Bridging Kit

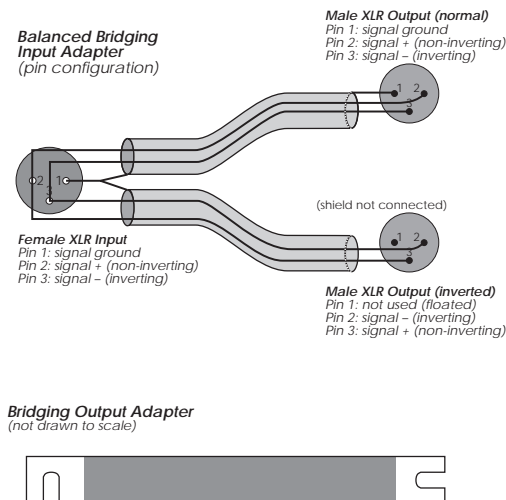

The “normal” leg of the Madrigal Balanced Bridging Input Adapter will be marked with a red stripe to indicate positive polarity, and the inverted leg will be marked with a black stripe to indicate inverted polarity (corresponding to the red and black terminals of your loudspeaker).

The Balanced Bridging Output Adapter is simply a heavy-gauge copper bar (silver- and gold-plated) used to strap two of the output ground terminals together. This establishes a common reference for the amplifier and completes the circuit that includes the loudspeakers.

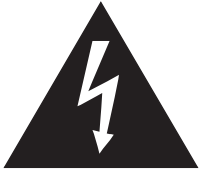

Important!

Do not attempt to operate your amplifier in a bridged mode without first strapping the black output terminals together. Failure to establish a common ground reference between the two channels can damage your amplifier by forcing significant currents to flow where they do not belong!

To bridge your Proceed amplifier using a balanced input signal, follow these steps:

1 DISCONNECT YOUR AMPLIFIER FROM EVERYTHING

Start with your amplifier totally disconnected from inputs, outputs, and AC power. It is always best to power down an amplifier before changing connections; here you are also changing its basic configuration, making it essential.

2 CONNECT THE BALANCED BRIDGING INPUT ADAPTER TO THE AMP'S INPUTS

Connect the two male XLRs to the inputs of your amplifier, noting which XLR is marked red and which is black. The channel with the red, normal input will later be connected to the red, positive terminal of your loudspeaker. Don't forget to choose the balanced input on each channel using the switch located between the XLR and the RCA connectors.

*Balanced Bridged
Input Connection*

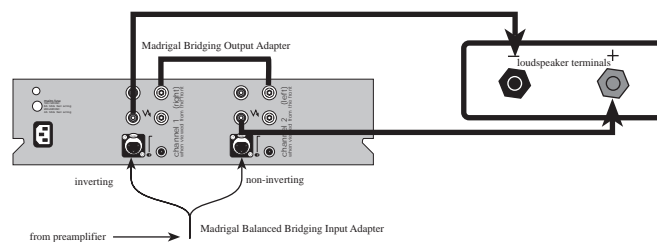

3 CONNECT THE BALANCED BRIDGING OUTPUT ADAPTER TO TWO BLACK OUTPUT TERMINALS

All Proceed amplifiers have two sets of output terminals per channel, wired in parallel (for convenience when biwiring). You may use either of the black output terminals. Connect one end of the Balanced Bridging Output Adapter to a black output terminal on one of the two channels to be bridged together, and then connect the other end of the Output Adapter to a black output terminal on the other channel. Make sure these connections are snug and secure.

4 CONNECT YOUR LOUDSPEAKER WIRE ACROSS TWO RED OUTPUT TERMINALS, ONE TO EACH OF THE TWO CHANNELS BEING BRIDGED

Connect the positive/+ /red binding post of your loudspeaker to the red output terminal associated with the red (normal) side of the Input Adapter. Connect the negative/- /black binding post of your loudspeaker to the *red* output terminal on the other side of the amplifier, the one associated with the black (inverted) side of the Input Adapter.

Following this connection convention preserves the polarity of the signal sent to the loudspeaker. In practice, the most important thing is to be consistent throughout the system, as inconsistency will result in out-of-phase loudspeakers. In turn, this results in unstable imaging and poor bass reproduction. (The effect is not dangerous, but neither is it desirable.)

5 CONNECT ONE OUTPUT CHANNEL OF YOUR PREAMPLIFIER TO THE INPUT OF YOUR BRIDGED AMPLIFIER

The female XLR at the junction of the Balanced Bridging Input Adapter is now the *single* input to this *bridged* pair of amplifier channels.

6 POWER UP YOUR AMPLIFIER

Plug the amplifier back into the AC mains; press the **power** button to turn on the amplifier.

7 REPEAT THIS PROCESS WITH YOUR OTHER AMPLIFIER(S)

Single-Ended Bridging

If your preamplifier has only single-ended (RCA) outputs, a few details of bridged operation will differ from the discussion above, all pertaining to the connection of the preamp to the bridged amplifiers. For this discussion, we will assume that you are using a Madrigal Single-Ended Bridging Kit for each channel to be bridged. (Alternatively, you may have custom cables built using your preferred wire and connectors, being careful to follow the wiring diagram below.)

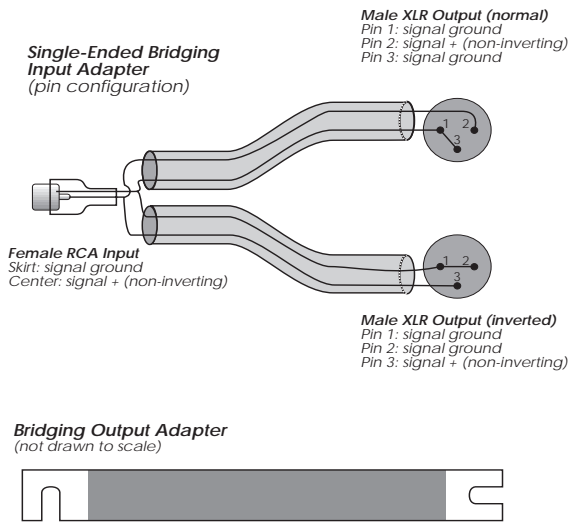

The “normal” leg of the Madrigal Single-Ended Bridging Input Adapter will be marked with a red stripe to indicate positive polarity, and the inverted leg will be marked with a black stripe to indicate inverted polarity (corresponding to the red and black terminals of your loudspeaker).

The Balanced Bridging Output Adapter is simply a heavy-gauge copper bar (silver- and gold-plated) used to strap two of the output ground terminals together. This establishes a common reference for the amplifier and completes the circuit that includes the loudspeakers.



Important!

Do not attempt to operate your amplifier in a bridged mode without first strapping the black output terminals together. Failure to establish a common ground reference between the two channels can damage your amplifier by forcing significant currents to flow where they do not belong!

To bridge your Proceed amplifier using a single-ended (RCA) input signal, follow these steps:

- 1 DISCONNECT YOUR AMPLIFIER FROM EVERYTHING**
Start with your amplifier totally disconnected from inputs, outputs, and AC power. It is always best to power down an amplifier before changing connections; here you are changing its basic configuration, making it essential.
- 2 CONNECT THE SINGLE-ENDED BRIDGING INPUT ADAPTER TO THE AMP'S INPUTS**
Connect the two male XLRs to the inputs of your amplifier, noting which XLR is marked red and which is black. You may want to standardize on “Red is Right” to avoid confusion, although it makes no difference to the amplifier. The channel with the red, normal input will later be connected to the red, positive terminal of your loudspeaker.

Single-Ended Bridged Input Connection

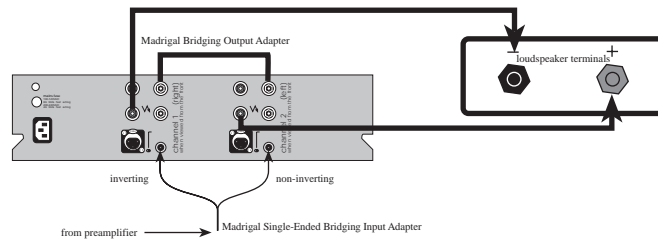

3 CONNECT ONE END OF THE SINGLE-ENDED BRIDGING OUTPUT ADAPTER TO TWO SIDE-BY-SIDE BLACK OUTPUT TERMINALS

All Proceed amplifiers have two sets of output terminals per channel, wired in parallel (for convenience when biwiring). You may use either of the black output terminals in each channel. Connect one end of the Balanced Bridging Output Adapter to a black output terminal on one side of the amplifier, and then connect the other end to a black output terminal on the other side of the amplifier. (The two connections should be side-by-side rather than one above the other.) Make sure these connections are snug and secure.

4 CONNECT YOUR LOUDSPEAKER WIRE ACROSS TWO SIDE-BY-SIDE, RED OUTPUT TERMINALS

In this case, you may use either the upper or the lower red output terminals. Connect the positive/+ /red binding post of your loudspeaker to the red output terminal associated with the red (normal) side of the Input Adapter. Connect the negative/- /black binding post of your loudspeaker to the red output terminal on the other side of the amplifier, the one associated with the black (inverted) side of the Input Adapter.

Following this connection convention preserves the polarity of the signal sent to the loudspeaker. In practice, the most important thing is to be consistent throughout the system, as inconsistency will result in out-of-phase loudspeakers. In turn, this results in unstable imaging and poor bass reproduction. (The effect is not dangerous, but neither is it subtle.)

5 CONNECT ONE OUTPUT CHANNEL OF YOUR PREAMPLIFIER TO THE INPUT OF YOUR BRIDGED AMPLIFIER

The female RCA at the junction of the Single-Ended Bridging Input Adapter is now the *single* input to this *bridged* amplifier.

6 POWER UP YOUR AMPLIFIER

Plug the amplifier back into the AC mains; press the **power** button to turn on the amplifier.

7 REPEAT THIS PROCESS WITH YOUR OTHER AMPLIFIER(S)

Biamplication

In contrast to bridged operation (wherein a two channel amplifier is “fooled” into behaving as a single, larger amplifier), biamplication makes use of a two-channel amplifier to drive *different portions* of a single loudspeaker. As with bridging, it offers a modular way of increasing the overall performance of your system (if your loudspeakers support biamplication).

Since each channel of the amplifier is delivering current into its load only over a limited range of frequencies (typically bass vs mids and treble), several forms of distortion are reduced as compared to each channel handling the full range of musical information. For this reason, many loudspeaker companies are designing their products to include multiple speaker inputs (since using multiple amplifiers improves the performance of their products as well). Another common use of biamplication involves adding a subwoofer (along with an appropriate electronic crossover) to supplement and/or improve the deep bass performance of your system.

Always refer to the specific directions provided by your loudspeaker manufacturer prior to setting up a biamplified speaker system. Any instructions contained herein cannot be substituted for those that are specific to the loudspeaker in question. In general, however, biamping is done in one of two ways: *active* biamplication, or *passive* biamplication.

Active biamping refers to the presence of an “active” electronic crossover that divides the music into two (or sometimes more) bands of frequencies. These are then forwarded to separate power amplifiers, and sent on directly to the appropriate drivers in the speakers. The most common application of this approach is the use of a subwoofer crossover to separate the deep bass (below, say, 80 Hz) from the rest of the program material. It is then amplified separately and sent to a dedicated subwoofer designed to handle those extremely low frequencies.

Apart from adding a subwoofer, the next most common form of biamping (called *passive* biamplication) involves merely using a conventional “Y-adapter” (either balanced or single-ended) to provide a full range signal to two channels.

Balanced Y-adapter

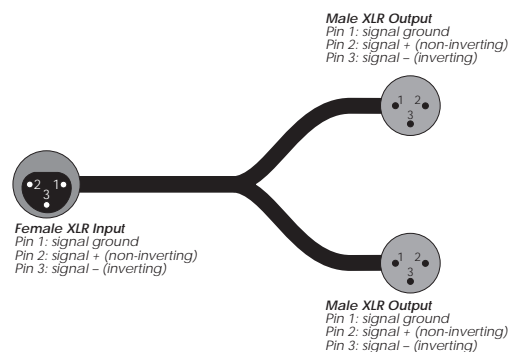

The outputs of these two channels are then connected to two sets of binding posts on each loudspeaker. (See below.) The loudspeaker’s internal crossover continues to divide the frequencies appropriately among the various drivers.

Biamping wiring diagram

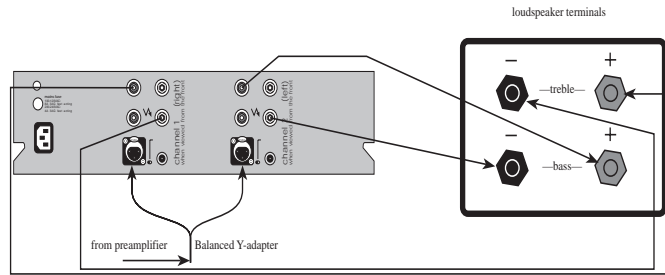

“Horizontal” biamping refers to the practice of using one amplifier for left and right low frequencies, and another for the high frequencies.

“Vertical” biamping (illustrated above) refers to the practice of using a single stereo amplifier for each loudspeaker (say, an AMP 2 driving each loudspeaker). Vertical biamping allows the amplifier to be placed extremely close to each speaker, keeping speaker leads as short as possible.

To facilitate biamping, all Proceed power amplifiers have the same voltage gain and input sensitivity. Because of this fact, you should not have to concern yourself with adjusting the relative volumes of the bass and treble sections of your loudspeakers—if they sounded good with a single amplifier, they should sound better when biamplified.

Care & Maintenance

To remove dust from the cabinet of your amplifier, use a feather duster or a lint-free soft cloth. To remove dirt and fingerprints, we recommend isopropyl alcohol and a soft cloth. Dampen the cloth with alcohol first and then lightly clean the surface of the amplifier with the cloth. Do not use excessive amounts of alcohol that might drip off the cloth and into the amplifier.



Caution!

At no time should liquid cleaners be applied directly to the amplifier, as direct application of liquids may result in damage to electronic components within the unit.

U.S. and Canadian Warranty

90-Day Limited Warranty

This Proceed® product is warranted to be free from defects in material and workmanship under normal use for a period of ninety (90) days from the date of purchase. **To extend the warranty of this Proceed product**, return the warranty registration card along with a copy of the original receipt of purchase to Madrigal Audio Laboratories, Inc., P. O. Box 781, Middletown, CT 06457.

Five Year Extended Warranty

The **extended warranty** for this Proceed product is **five (5) years** from the date of purchase. During the warranty period, any Proceed component exhibiting defects in materials and/or workmanship will be repaired or replaced, at our option, without charge for either parts or labor, at our factory. The warranty will not apply to any Proceed component that has been misused, abused or altered.

Any Proceed component not performing satisfactorily may be returned to the factory for evaluation. Return authorization must first be obtained by either calling or writing the factory prior to shipping the component. The factory will pay for return shipping charges only in the event that the component is found to be defective as above mentioned. There are other stipulations that may apply to shipping charges.

There is no other express warranty on this component. Neither this warranty nor any other warranty, express or implied, including any implied warranties of merchantability or fitness, shall extend beyond the warranty period. No responsibility is assumed for any incidental or consequential damages. Some states do not allow limitations on how long an implied warranty lasts and other states do not allow the exclusion or limitation of incidental or consequential damages, so that the above limitation or exclusion may not apply to you.

This warranty gives you specific legal rights, and you may also have other rights which vary from state to state. **This warranty is applicable in the United States and Canada only.** Outside of the U.S. and Canada, please contact your local, authorized Proceed distributor for warranty and service information.

Obtaining Service

We take great pride in our dealers. Experience, dedication, and integrity make these professionals ideally suited to assist with our customers' service needs.

If your Proceed component must be serviced, please contact your dealer. Your dealer will then decide whether the problem can be remedied locally, or whether to contact Madrigal for further service information or parts, or to obtain a Return Authorization. The Madrigal Technical Services Department works closely with your dealer to solve your service needs expediently.



Important!

Return authorization must be obtained from Madrigal's Technical Services Department BEFORE a unit is shipped for service.

It is extremely important that information about a problem be explicit and complete. A specific, comprehensive description of the problem helps your dealer and the Madrigal Technical Services Department locate and repair the difficulty as quickly as possible.

A copy of the original bill of sale will serve to verify warranty status. Please include it with the unit when it is brought in for warranty service.



Warning!

All returned units must be properly packaged (preferably in their original packing material), and the proper return authorization numbers must be marked on the outer carton for identification. If the packaging to protect the unit is, in our opinion or that of our dealer, inadequate to protect the unit, we reserve the right to repackage it for return shipment at the owner's expense. Neither Madrigal nor your dealer can be responsible for shipping damage due to improper (that is, non-original) packaging.

Your dealer can order a new set of shipping materials for you if you need to ship your component and no longer have the original materials. There will be a charge for this service. We *strongly* recommend saving all packing materials in case you need to ship your unit some day.

Specifications

The correlation between published specifications and performance is unreliable. A list of numbers reveals virtually nothing. All technical measurements must be subject to qualitative as well as quantitative interpretation. Measurements of the Proceed AMP yield excellent results by any standards. However, only those specifications that apply to its actual operation are included here. All specifications are subject to change at any time, in order to improve the product.

- **Rated power output:** 150 w/ch rms @ 8 Ω , all channels driven,
20 Hz–20 kHz with no more than 0.1% THD
250 w/ch into 4 Ω
- **Frequency response:** within 0.1 dB from 20 Hz to 20 kHz
- **Signal to Noise ratio (main outputs):** better than –80 dB (ref. 1 w)
- **Input impedance:** 30k Ω (balanced)
100k Ω (single-ended)
- **Voltage gain:** 23 dB (balanced)
29 dB (single-ended)
- **Input sensitivity:** 2.4 V for full rated output (balanced)
1.2 V for full rated output (single-ended)
- **Power consumption:** typically 140 W at idle (AMP 2)
typically 210 W at idle (AMP 3)
- **Mains voltage:** determined by the needs of country for which
the unit was manufactured; cannot be reset by dealer or user
- **Overall dimensions:** See “Dimensions”
- **Shipping weight:** 47 lbs. (21.4 kg) for AMP 2
61 lbs. (27.7 kg) for AMP 3
- **Connector Complement:** four binding posts per channel
one 3-pin XLR balanced input connector per channel
1 RCA input connector per channel
1 1/8" mini-jack for remote turn-on
one IEC AC mains connector
- **Output impedance:** less than 0.05 Ω

For more information, see your Proceed dealer, or contact:

Madrigal Audio Laboratories, Inc.

P.O. Box 781

2081 South Main Street (Route 17)

Middletown, Connecticut 06457 USA

Telephone (860) 346-0896

FAX (860) 346-1540

Internet <http://www.madrigal.com/>

Madrigal provides an owner-transferable, five year extended warranty on all Proceed products within the U. S. and Canada ONLY. Warranty and service policies outside the U. S. and Canada are set by the local, authorized distributor and are applicable in the country of purchase ONLY. Madrigal products are designed to operate at set voltages appropriate for the country of sale and may be damaged if operated at the wrong voltage. contact your local dealer or distributor.

Dimensions: AMP 2

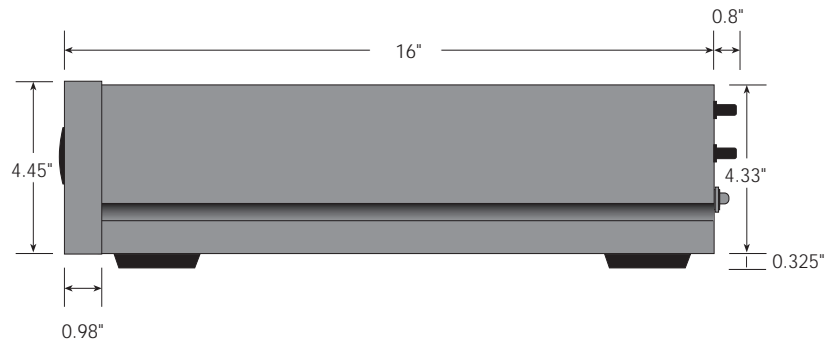
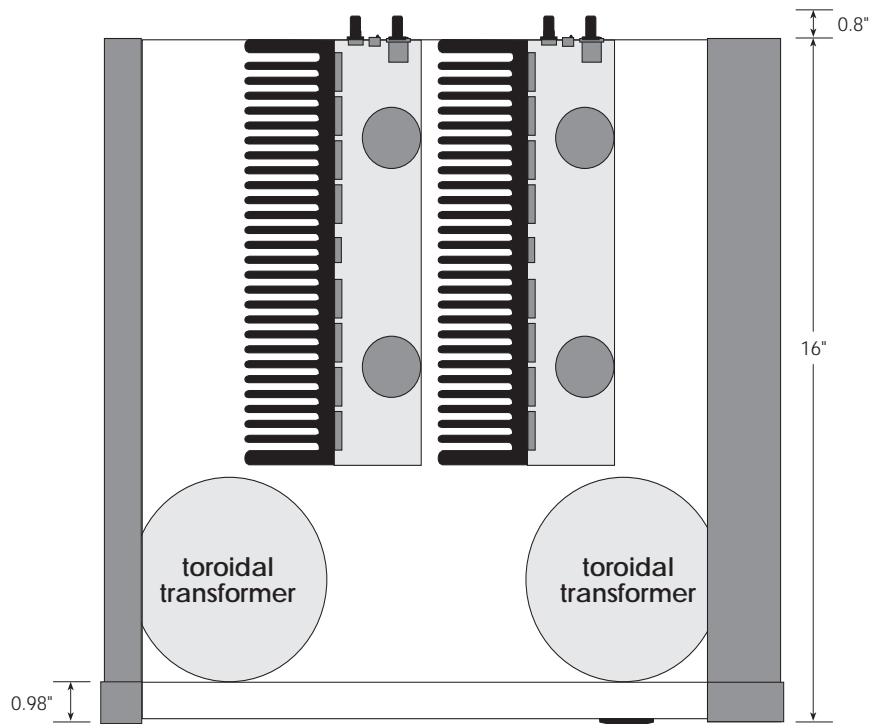
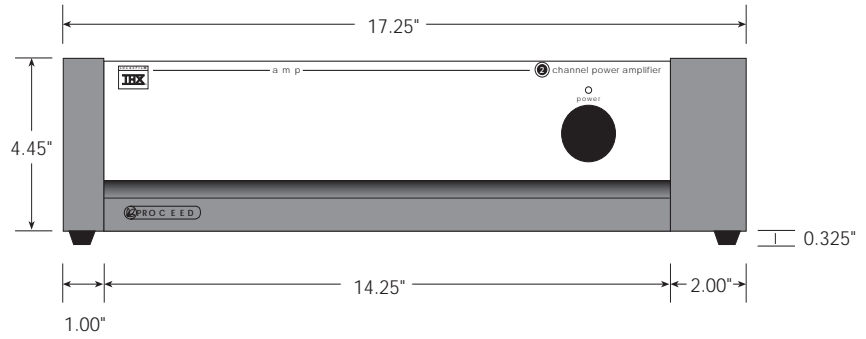

Dimensions: AMP 3

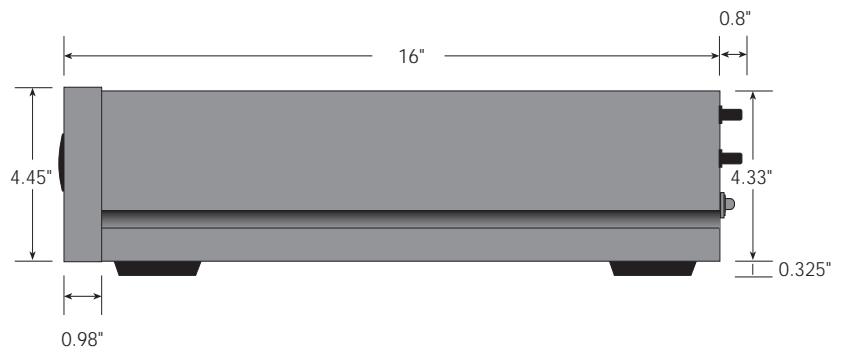
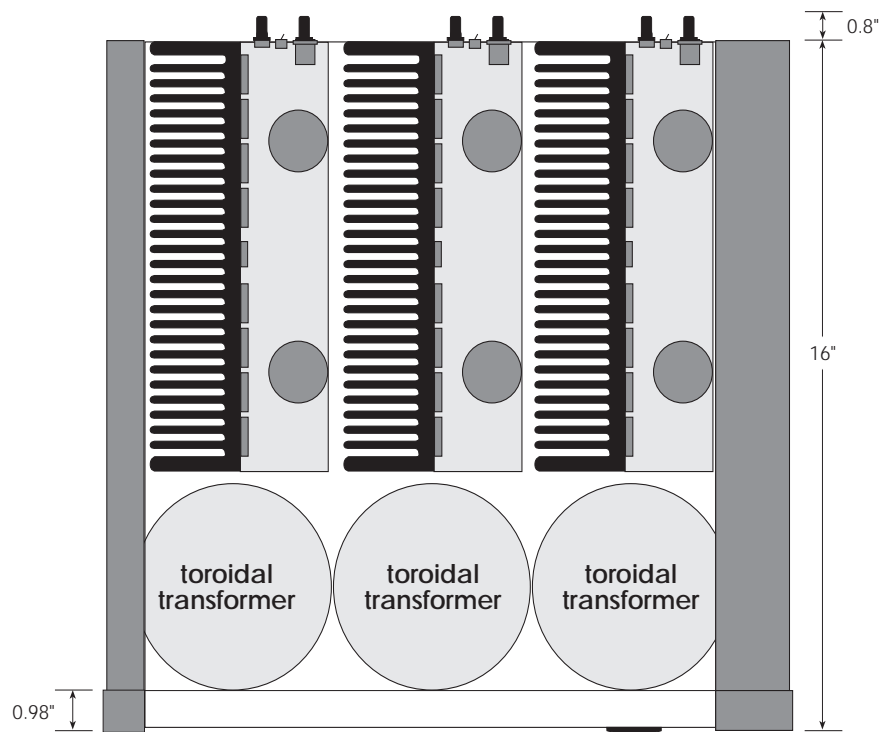
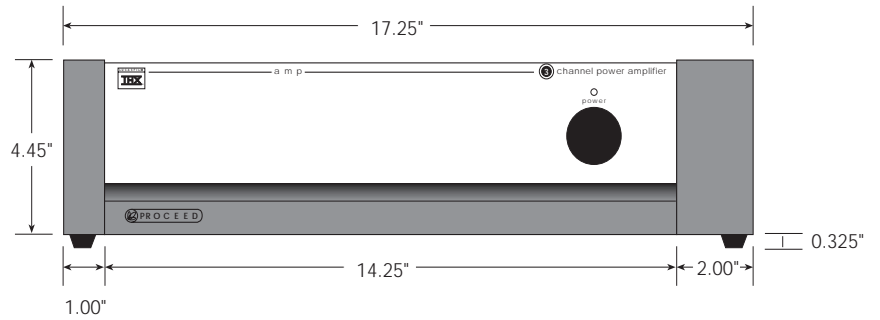



MADRIGAL

Madrigal Audio Laboratories, Inc.
2081 South Main Street, P.O. Box 781
Middletown, Connecticut 06457 USA

Telephone: (860) 346-0896
Fax: (860) 346-1540
<http://www.madrigal.com/>

 **PROCEED**[®]

is a registered trademark of Madrigal Audio Laboratories, Inc.
H a Harman International company